

F00RJ01945 Injector Valve Assembly Technical File

SKU: G1L10F00RJ01945



F00RJ01945 Injector Valve Assembly Technical File

Content

1. F00RJ01945 Injector Valve Assembly Introduction	3
1.1.F00RJ01945 Injector Valve Assembly Basic Information	3
1.2.F00RJ01945 Injector Valve Assembly Application Information for Injectors.....	3
1.3.F00RJ01945 Injector Valve Assembly Specifications and Dimensions Parameters	3
1.4.F00RJ01945 Injector Valve Assembly Quality Control	4
1.5.F00RJ01945 Injector Valve Assembly Customized Service	4
1.6.F00RJ01945 Injector Valve Assembly Packing List.....	5
1.7.F00RJ01945 Injector Valve Assembly Warranty Instructions	6
1.8.F00RJ01945 Injector Valve Assembly Manufacturer	6
2.F00RJ01945 Injector Valve Assembly Technical Support.....	6
2.1.F00RJ01945 Injector Valve Assembly Installation Precautions.....	6
2.2.F00RJ01945 Injector Valve Assembly Replacement Conditions.....	7
2.3.F00RJ01945 Injector Valve Assembly Installation Steps.....	8
2.4.F00RJ01945 Injector Valve assembly Technical Support Obtaining Methods	20
3.F00RJ01945 Injector Valve Assembly Purchase and Delivery.....	20
3.1.F00RJ01945 Injector Valve Assembly Purchase Payment Terms.....	20
3.2.F00RJ01945 Injector Valve Assembly Main Sales Market.	20
3.3.F00RJ01945 Injector Valve Assembly Declaration Requirements	20
3.4.F00RJ01945 Injector Valve Assembly Shipping Ways	20
3.5.F00RJ01945 Injector Valve Assembly Lead Time.....	21
3.6.F00RJ01945 Injector Valve Assembly Logistics Time for Destination Out of China's Areas.....	21
3.7.F00RJ01945 Injector Valve Assembly Packing	22
4.F00RJ01945 Injector Valve Assembly Storage Standard.....	23
5. Company Information.....	23
5.1. Company Introduction	23
5.2. Contact Information.....	24
6. Copyright Statement.....	24

F00RJ01945 Injector Valve Assembly Technical File

1. F00RJ01945 Injector Valve Assembly Introduction

Injector valve assembly is one of the most important running parts, it is consisted of valve rod and valve cap, installed in the controlling room in the house body of injector. The main function of injector valve assembly is to control oil injection and oil return. Injector valve assembly is one of the most core components, also one of parts with the highest damage rate.

Valve cap: When checking the valve cap, you need to use microscope to observe the contact surface between the valve cap and the ball to see whether the valve cap is damaged or not, if there is damage, the valve cap must be replaced.

Valve rod:

1. Check the top of valve rod which has contact with valve cap, if the valve rod has damage on the surface, its original silver color turns into white, the valve rod needs to be replaced.
2. Check the valve rod's contact part with injector, if the valve rod has damage on the surface, its original silver color turns into white, the valve rod needs to be replaced.

1.1.F00RJ01945 Injector Valve Assembly Basic Information

Title	F00RJ01945 Fuel Injector Valve Assembly 0445120 Series	Quality
SKU	G1L10F00RJ01945	China Made New

1.2.F00RJ01945 Injector Valve Assembly Application Information for Injectors

(1) F00RJ01945 Injector Valve Assembly Car Model Matching Information

Injector Part Number	Car Model	OE Number
0445120046	CUMMINS	3 968 546
		3 968 846

(2) F00RJ01945 Injector Valve Assembly Application for Injectors' Part Number

Injector Series	Injector Part Number	Universal Number	Universal Number	System Pressure (bar)
CRIN1-14/16	0445120046	0445120113	0445120114	/

(3) F00RJ01945 Injector Valve Assembly Part Number Common Writing

F00RJ01945, FOO RJ01945, F 00R J01 945, F OOR J01 945, F00R J01 945, FOOR J01 945, FOORJ01945, F 00R J01945, F OORJ01945, F 00RJ01945, F OORJ01945, F00R J01945, FOORJ01945

1.3.F00RJ01945 Injector Valve Assembly Specifications and Dimensions Parameters

Injector Valve Assembly Size: 11cm*18cm *3 cm

Injector Valve Assembly Box Size: 12 cm *19 cm *4 cm

Injector Valve Assembly Net Weight: 0.02kg

Injector Valve Assembly Gross Weight: 0.05kg

Injector Valve Assembly Quality: China Made New Injector Valve Assembly

Injector Valve Assembly MOQ: 4PCS

1.4.F00RJ01945 Injector Valve Assembly Quality Control

(1) Injector Valve Assembly Testing

All parts of the injector valve assembly have undergone precision testing, high temperature testing, low temperature testing, withstand pressure testing, leakage testing, durability testing, and various working conditions testing.

(2) Injector Valve Assembly Inspection

The factory inspection of the injector valve assembly is undergone three inspections: full inspection, random inspection, and batch inspection. Different brands of test benches are used to test the same injector valve assembly for a total of no less than three times for factory inspection, and the fuel injector valve assembly's installation and testing environment are progressed in dust-free workshop.

(3) Injector Valve Assembly Installation

When matching the valve cap and valve stem, Shumatt strictly complies with the standard of valve cap and valve stem clearance technical indicators to ensure that each valve assembly meets the factory standards and use standards.

1.5.F00RJ01945 Injector Valve Assembly Customized Service

(1) **Injector Valve Assembly Customized Service:** Meet the customized needs of OEM manufacturers for valve color and lustre, valve cap groove customization, valve cap lettering, valve cap logo engraving, valve cap QR code engraving, valve assembly internal packaging, valve assembly external packaging and label customization needs.

		
Valve Cap Color And Lustre Customized 1000 pieces (White color is optional)	Valve Cap Color And Lustre Customized 1000 pieces (Purple red color is optional)	Valve Cap Groove Customized
		
Valve Cap Lettering, Valve Cap logo Engraving, Valve Cap QR Code Engraving Customization	Valve Assembly Box (Square is optional)	Valve Assembly Box (Cylindrical is optional)
		/
Valve Assembly Bag	Valve Assembly Label 7cm*5cm	/

(2) Injector Valve Assembly Customized Service Requirements:

Customized valve assembly box are no less than 100 pieces.

Customized valve assembly groove no less than 100 pieces.

The purchased of customized valve assembly are no less than 1000 pieces.

The purchased of customized valve cap engraving contents are no less than 1000 pieces.





The purchased of customized valve colors are no less than between 1000 -10000 pieces.

Customized products involve the need of specify logo, the OEM manufacturer needs to provide trademark authorization and the sample of logo image file.

▲ Once the customized injector valve assembly is sold, it can not be returned or exchanged if there is no quality problems.

1.6.F00RJ01945 Injector Valve Assembly Packing List

(1) Injector Valve Assembly Spare Parts List

Serial Number	1	2	3
Image			
Name	Injector Valve Assembly	Injector Valve Assembly Anti-rust Paper	Injector Valve Assembly Box (Square is optional)
Description	Injector Valve Assembly Part Number F00RJ01945	Prevent the injector valve assembly from rusting	Protect the injector valve assembly from being damaged by colliding
Serial Number	4	5	/
Image			/
Name	Injector Valve Assembly Box (Cylindrical is optional)	VCI Anti-rust Bag	/
Description	Protect the injector valve assembly from being damaged by colliding	Prevent the injector valve assembly from rusting	/

▲ Minors are prohibited from using the injector valve assembly, valve assembly anti-rust paper, valve assembly box, and VCI anti-rust bag to avoid personal injury.

▲ The valve assembly box is recyclable and can be reused.

▲ VCI anti-rust bag is non-degradable material, please dispose of it properly after use.

1.7.F00RJ01945 Injector Valve Assembly Warranty Instructions**(1) . Injector Valve Assembly Warranty Conditions and Instructions**

It is necessary to provide pictures, videos, or test reports detected by the injector valve assembly inspection equipment when the valve assembly is abnormal during use as evidence to feed back to the salesman.

Abnormal conditions are properly explained such as:1.Smoke, 2. Engine shake, 3. Difficulty starting the engine, 4. Engine noise, 5.Oil leakage and other abnormal conditions.

The above condition may also be affected by other components of the injector. If it is confirmed by our company to be a product problem, it is within the scope of the subsidy.

(2) . Injector valve Assembly Warranty Coverage

Within 15 days after customer receives the **F00RJ01945** injector valve assembly, if there is a performance failure and the product has no appearance damage, customer can choose to replace it;

If the **F00RJ01945** injector valve assembly has performance problems during the warranty period (3 months), and it is confirmed that it is product's problems after being tested, you can contact our salesmen to replace the same model for free;

If the product is confirmed to be fault-free, the product will be returned.

(3) . Injector Valve Assembly Out of Warranty Coverage

The warranty period has expired, not covered by warranty.

Injector valve assembly failure caused by high temperature, high pressure, humidity, rain and snow, saline-alkali land, earthquake, and used in abnormal environment.

Injector valve assembly damage caused by man-made reasons (throwing, strong magnetic field magnetization, set fire).

Injector valve assembly failure or injector damage caused by non-injector design, technology, manufacturing, quality and other issues.

Injector valve assembly failure due to system pressure exceeding system approved pressure.

Injector valve assembly failure caused by impurities (water, lead, aluminum powder, iron powder, sulfide) in the system fuel exceeding the standard requirements.

Injector valve assembly failure caused by not installing according to the tightening torque specified in the vehicle engine maintenance manual (the tightening torque is too large or too small).

Injector valve assembly failure caused by not following the installation angle specified in the injector maintenance manual.

Injector valve assembly failure caused by not following the cleaning requirements specified in the injector maintenance manual.

Injector valve assembly failure caused by failure to replace consumable parts as specified in the injector maintenance manual.

1.8.F00RJ01945 Injector Valve Assembly Manufacturer

Injector Valve Assembly Manufacturer: Shenzhen Shumatt Technology Co.,Ltd

2.F00RJ01945 Injector Valve Assembly Technical Support**2.1.F00RJ01945 Injector Valve Assembly Installation Precautions**

- (1) **Clean the injector valve assembly in an ultrasonic cleaner for 3-5 minutes before installation, so as to make the stains, dust, rust-proof oil oxides**, paraffin base, naphthenic base, intermediate base, salt, lead naphthenate, zinc naphthenate, sodium petroleum sulfonate, barium petroleum sulfonate, calcium petroleum sulfonate, tallow diamine trioleate, rosinamine on the surface of the injector valve assembly fall off.
- (2) Use compressed air to clean the cleaning fluid attached to the surface of the injector valve assembly after cleaning, and clean it up to the standard of use.
- (3) When installing the steel ball and ball seat, pay attention to the steel ball should close tightly to the oil return hole at the top of the valve cap,as shown in the following figure.

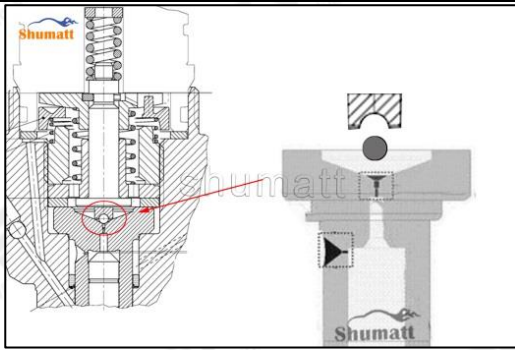

- (4) When installing the valve stem, make sure that the valve stem and the bonnet must ensure that the valve stem can move smoothly in it. as below

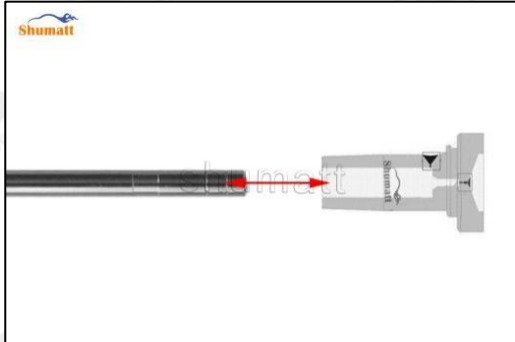





- (5) When installing the injector valve assembly, the oil inlet position should be 180° between the oil inlet position of the injector body.

If the injector steel ball and the ball seat are not installed in accordance with the standard, it may cause serious damage to the injector valve assembly.

2.2.F00RJ01945 Injector Valve Assembly Replacement Conditions

(1) Valve Cap

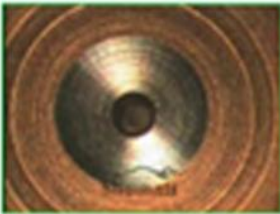
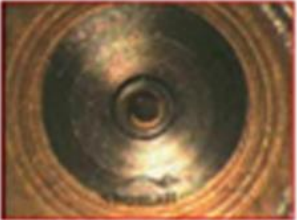

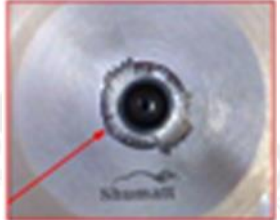
Under the microscope, magnify 20 times to check that the oil inlet hole of the valve cap and the oil return hole of the bonnet are not worn, grooved, scratched, damaged, rusted or dented.

		
Injector valve cap inlet hole location	Injector valve cap return hole location	The oil inlet and oil return holes of the injector valve cap are free of wear, grooves, scratches, damage, rust, dents, which do not need to be replaced
		
The injector valve cap oil hole is recessed and needs to be replaced	The injector valve cap oil hole is worn and needs to be replaced	The injector valve cap oil hole is punched and needs to be replaced

- ⚠ The wear of the top oil return hole causes the oil return to be too large and the leaking injector cannot inject oil.
- ⚠ The oil inlet hole on the side is blocked, causing the injector to fail to establish the pressure chamber and the injector cannot work normally
- ⚠ Wear of the oil chamber of the valve cap will cause fuel injector failure. In severe cases, the fuel injector will not work properly.

(2) Valve Rod

Microscope amplification 20 times, check the valve rod for wear, not smooth surface color, rust

		
The valve stem is worn out and needs to be replaced	The valve stem surface is not smooth and colorless, and it needs to be replaced	The valve stem is rusty and needs to be replaced

- ⚠ The excessive clearance between the valve stem wear, housing and the valve cap will causes injector lag.
- ⚠ The valve stem lag will cause the injector to start the solenoid to start, and the oil needle can not return quickly after the nozzle is opened.
- ⚠ Check the injector components before replacing the injector valve assembly according following the injector service manual to avoid further damage to the injector valve assembly after replacement.

2.3.F00RJ01945 Injector Valve Assembly Installation Steps

(1) Use special installation tools - the sealing ring and support ring in CRT029 to put them into the injector housing, as shown in picture No. 1



Pic No.1

(2) Place the valve assembly into the injector and use the special tools in CRT029 to install the valve assembly in place, as shown in picture No. 2



Pic No.2

(3) Take out the buffer spring, steel ball and ball seat for later use, as shown in picture No. 3



Pic No.3

(4) Place the armature stroke adjust shim into the injector, as shown in picture No. 4



Pic No.4

(5) Place the armature core into the injector, as shown in picture No. 5



Pic No.5

(6) Place the armature lower plate into the injector, as shown in picture No. 6



Pic No.6

(7) Place the lock nut into the injector, as shown in picture No. 7



Pic No.7

(8) Use the special tool for tightening the lock nut in CRT029 to tighten the lock nut to 65Nm, as shown in picture No. 8



Pic No.8

(9) Put in the armature, as shown in picture No. 9



Pic No.9

(10) Press the armature plate downward so that the opening buffer stroke adjust washer can be stuck in the slot on the armature core, as shown in picture No. 10



Pic No.10

(11) Put in the armature stroke adjust shim, as shown in picture No. 11



Pic No.11

(12) To measure the stroke without the buffer spring, steel ball, and ball seat, use the CRT220 tool (Tool No. 1), as shown in picture No. 12



Pic No.12

(13) Install the measuring tool on the injector and reset it to zero, as shown in picture No. 13



Pic No.13

(14) After installing the buffer spring, steel ball, and ball seat, install the measuring tool. The value displayed by the measuring tool is the value of the buffer stroke (15-45um). If it is greater than the normal value, reduce the buffer stroke adjustment shim. If it is smaller than the normal value, thicken the buffer stroke adjustment gasket, as shown in picture No. 14



Pic No.14

(15) Return the measuring tool to zero again, as shown in picture No. 15



Pic No.15

(16) The value reached by pressing the gauge rod is the armature stroke (45-55um). If the value is greater than the normal value, reduce the armature stroke adjustment washer. If the value is less than the normal value, thicken the armature stroke adjustment washer, as shown in picture No. 16.



Pic No.16

(17) Replace the measurement tool and use the (No. 5 tool) in the CRT220 tool and perform zeroing, as shown in picture No. 17



Pic No.17

(18) Measure the distance from the inner plane to the outer plane of the solenoid valve and record it as A (5510), as shown in picture No. 18



Pic No.18

(19) Measure the distance from the armature plate plane at the end of the injector to the remaining air gap adjust washer shim again and record it as B (5498), as shown in picture No. 19



Pic No.19

(20) Residual air gap = A data - B data. The value of the remaining air gap is 45-55Nm. If it is greater than the normal value, reduce the remaining air gap stroke adjust washer shim. If it is less than the normal value, thicken the remaining air gap stroke adjust washer shim, as shown in picture No. 20

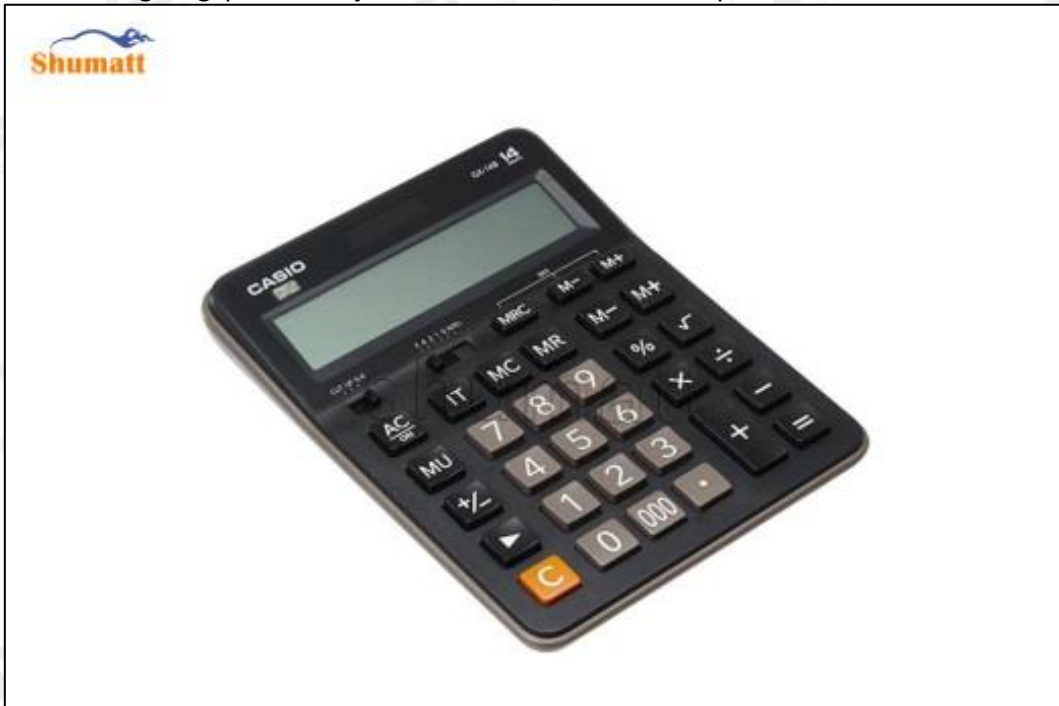

Pic No.20

(21) Place the solenoid valve spring into the injector, as shown in picture No. 21



Pic No.21

(22) Place the solenoid valve spring adjust washer shim into the injector, as shown in picture No. 22



Pic No.22

(23) Tighten the solenoid valve to a 45 degree angle, as shown in picture No. 23



Pic No.23

(24) Use the solenoid valve nut open-end wrench to tighten it to 35Nm, as shown in picture No. 24



Pic No.24

2.4.F00RJ01945 Injector Valve assembly Technical Support Obtaining Methods

- (1) Valve Assembly Technical File, visit <http://shumatt.com> to get the technical file
- (2) **Injector Valve Assembly Technical Videos**

Facebook: Visit <https://www.facebook.com/hison.li> to get technical support videos and stay tuned for more information.

YouTube: https://www.youtube.com/channel/UCByvYBx7VjV_mAfxh_Hu-aw to get the technical support videos, constantly follow can get more information.

Shumatt: Visit <http://shumatt.com> to get the technical support videos.

- (3) Valve Assembly Information Query Software

TruckBook Parts EPC APP, Android/Apple App Store download and install, visit <http://shumatt.com> to get the download and installation tutorial

- (4) Search The injector valve assembly test data through TruckBook Parts EPC APP.

3.F00RJ01945 Injector Valve Assembly Purchase and Delivery.

3.1.F00RJ01945 Injector Valve Assembly Purchase Payment Terms

Payment Terms: T/T, PayPal, Alipay, WeChat

Please contact our salesmen for specific payment information.

3.2.F00RJ01945 Injector Valve Assembly Main Sales Market.

Injector valve assembly main sales markets: Asia, Europe, North America, South America, Africa etc.

3.3.F00RJ01945 Injector Valve Assembly Declaration Requirements

Shumatt can assist customers to provide the following documents for import customs clearance: contract, invoice, packing list, bill of lading, insurance policy, certificate of origin, etc.

3.4.F00RJ01945 Injector Valve Assembly Shipping Ways

Destination in China areas: SF Express, Debon Express, the corresponding logistics company can be

provided according to customer requirements in special cases.

Destinations out of China's areas: DHL, UPS, FedEx, TNT air, ocean or other shipping methods required by customers.

3.5.F00RJ01945 Injector Valve Assembly Lead Time

Lead time: Send out within 3 – 7 working days after receiving payment(Except for special products and special cases).

3.6.F00RJ01945 Injector Valve Assembly Logistics Time for Destination Out of China's Areas

DHL Logistics Time:

Country or Region of Departure	Hong Kong, China	Other Countries or Regions of Asia	Australia and New Zealand	Europe	America	Other Countries
China's Mainland	7 Days	7 Days	8 Days	8 Days	8-12 Days	7-10 Days

UPS Logistics Time:Country or Region of Departure: China's Mainland

Country of Destination	Estimated Arrival Time	Country of Destination	Estimated Arrival Time	Country of Destination	Estimated Arrival Time
Japan	3 Days	UK	5-7 Days	Egypt	5-7 Days
Turkey	5-7 Days	Singapore	3 Days	Switzerland	5-7 Days
Bahrain	5-7 Days	Latvia	7-10 Days	New Zealand	7-10 Days
Sri Lanka	5-7 Days	Thailand	3 Days	Austria	5-7 Days
Romania	5-7 Days	Vietnam	3-5 Days	Estonia	5-7 Days
Malaysia	3-5 Days	Israel	5-7 Days	Mexico	7-10 Days
France	5-7 Days	America	5-7 Days	United Arab Emirates	5-7 Days
Italy	5-7 Days	Netherlands	5-7 Days	Bengal	7-10 Days
Lebanon	5-7 Days	Philippine	3-5 Days	Greece	7-10 Days
South Korea	3 Days	Spain	5-7 Days	Myanmar	5-7 Days
Canada	5-7 Days	Germany	5-7 Days	Saudi Arabia	7-10 Days
Portugal	5-7 Days	Australia	5-7 Days	South Africa	7-10 Days
Denmark	5-7 Days	Belgium	5-7 Days	Ukraine	7-10 Days
India	7-10 Days	Qatar	7-10 Days	Poland	5-7 Days
Indonesia	3-5 Days	Morocco	7-10 Days	Pakistan	7-10 Days
Kuwait	7-10 Days	/	/	/	/

The logistics time is for reference only, subjects are according to the actual arrival.

3.7.F00RJ01945 Injector Valve Assembly Packing

Domestic express packaging: Usually wrapped in waterproof scotch tape, such as picture No.1.

International express packaging: Wrapped with waterproof yellow tape After wrapping the black protective film, such as picture No. 2.

Pallet Shipping: Use fumigation free and recycling trays that meet export requirements, and use white wrapping protective film to wrap and bind with cable ties for the outside, such as picture No. 3,
Also, the products can be packaged according to customers' requirements.

- ⚠ The packing tray is made of plastic and can be recycled.
- ⚠ Transparent tape, yellow tape, black wrapping protective film, white wrapping protective film are non-degradable materials, please dispose of them properly.
- ⚠ Minors are prohibited from using transparent tape, yellow tape, black wrapping protective film, and white wrapping protective film to avoid personal injury.



Pic No.1

Domestic express packaging:
Wrapped by Transparent tape

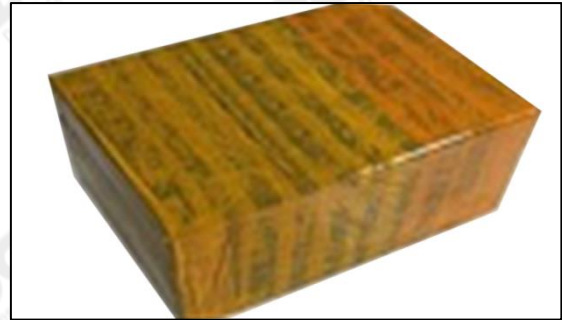

Pic No.2

International express packaging:
Wrapped with yellow tape after wrapping
black protective film



Pic No.3

Pallet Shipping: Use pallet that meet export requirements, and use white wrapping protective film to wrap and bind with cable ties

4. F00RJ01945 Injector Valve Assembly Storage Standard

(1) Choose a suitable storage place

The warehouse and cargo yard where the fuel injector valve assembly is stored should be kept clean and dry, and away from the factory buildings that generate harmful gases and dust; do not mix with acid, alkali, salt and other substances; the storage place should have a good drainage system; the cargo yard should be flattened with gravel or furnace ash etc. to enhance the water permeability of the surface layer to keep the reservoir area dry.

(2) Strict requirements of warehousing

Strict inspections should be carried out when the fuel injector valve assemblies are put into storage, the surface cleaning work should be done well to remove water traces, oil stains, ash and other dirt, remove the rust and do anti-rust treatment in time. Packaged Injector Valve Assembly must be protected from damage.

(3) Keep the warehouse dry and preventing moisture

The relative humidity is usually below 70% for the fuel injector valve assembly placed in the room, and the corrosion of the fuel injector valve assembly is significantly reduced.

Injector valve assembly must be stored in the warehouse, and they are forbidden to store in the same warehouse with commodities with high water content.

(4) Stack Properly

After the injector valve assembly is exposed to rain, the corrosion rate will increase significantly. The purpose of sealing is to isolate the injector valve assembly from rainwater and humid air, so the warehouse window should be checked in time to avoid rainwater entering the warehouse

If the injector valve assembly package is damaged, it should be repaired or replaced; when the package is damp, the packaging material should be dried; if the original anti-corrosion and oil applied at the factory is found to be damaged or dried up, it should be cleaned and re-applied oil in time.

▲ It is forbidden to leave the injector valve assembly exposed in the air for a long time.

▲ It is forbidden to store acid, alkali, salt and other substances together with the injector valve assembly.

▲ The unpacked injector valve assembly must be rust-proof during secondary storage.

5. Company Information



5.1. Company Introduction

Chinese Name: 深圳市舒马特科技有限公司

English Name: Shenzhen Shumatt Technology Co., Ltd

Mob Phone/WeChat: +86-13410541523

HK Telephone: +852-67653519

Telephone: +86-755-23215133

Email: ruby@shumatt.com

Website: www.shumatt.net

Shenzhen Office: 11-12, Floor 14, Building 13, Qinchengda Building, Exit A, Honglang North Subway Station, Bao'an District, Shenzhen, China's Mainland

Shenzhen Office: Exit C, Qiao Touxu Metro Station, NO. 66 Chongqing Road, Fuhai Avenue, Bao'an District, Shenzhen, China Mainland

Hong Kong Office: Jianfa Street Industrial Zone, Tuen Mun, New Territories, Hong Kong, China

After-sales Service Address: Please contact our salesmen to obtain and provide the corresponding product maintenance reasons (Reference: [1.7 F00RJ01945 Injector Valve Assembly Warranty Instructions](#))

5.2. Contact Information

Name	WeChat/ WhatsApp	Email
Ruby	+86-13410541523	hison@shumatt.com

6. Copyright Statement

The data above is quoted from the "F00RJ01945 Injector Valve assembly Technical File" of Shenzhen Shumatt Technology Co., Ltd. Dieselcontrolvalveset.com has been authorized to use by Shenzhen Shumatt Technology Co., Ltd. The copyright of any contents provided in "F00RJ01945 Injector Valve assembly Technical File" (including but not limited to parameters, data, text, charts, images, sounds or videos, etc.) belong to Shenzhen Shumatt Technology Co., Ltd. If there is any request, please email to hison@shumatt.com.